

Contemporary Lighting™

Item/Model Number:: E21441
Memaïd 1-Light LED Pendant

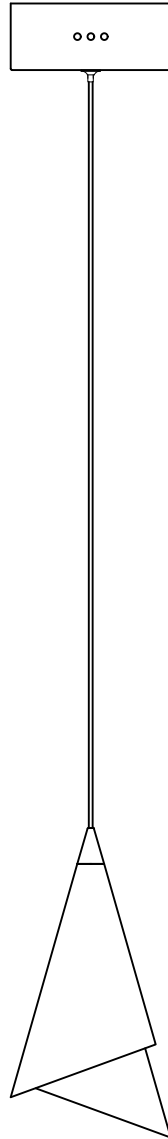

Lamping | Ampoule: "1 x LED 7.2W (Included)"

Please consult a qualified electrician prior to install
Veuillez consulter un électricien qualifié pour suspendre le luminaire et le câblage.
Made in China | Fabrique en Chine | Hecho en China

LED LOW-VOLTAGE INSTRUCTIONS

English Before Getting Started	Français Avant de Commencer	Español Antes de Comenzar
Read the instructions carefully prior to assembling the product.	Lire attentivement les instructions avant d'assembler le produit.	Lea atentamente las instrucciones antes de ensamblar el producto.
When you open the package with a sharp tool like a box knife, be careful not to damage the components inside.	Lorsque vous ouvrez le paquet avec un outil pointu comme un couteau de coupe, veillez à ne pas endommager les composants à l'intérieur.	Cuando abra el paquete con una herramienta afilada como un cuchillo de corte, tenga cuidado de no dañar los componentes dentro.
Carefully remove all packaging materials and retain for future use.	Retirez soigneusement tous les matériaux d'emballage et conservez-les pour un usage ultérieur.	Retire con cuidado todos los materiales de embalaje y consérvelos para usarlos en el futuro.
Keep all hardware parts and packaging out of reach of small children.	Conservez toutes les pièces matérielles et les emballages hors de portée des petits enfants.	Mantenga todas las piezas y embalajes de hardware fuera del alcance de los niños pequeños.
Choose a clean, level, spacious assembly area. Avoid hard surfaces that may damage the product.	Choisissez une zone d'assemblage propre, de niveau et spacieuse. Évitez les surfaces dures qui pourraient endommager le produit.	Elija una zona de ensamblaje limpia, nivelada y espaciosa. Evite superficies duras que puedan dañar el producto.
Ensure that you have all required contents for complete assembly.	Assurez-vous que vous avez tous les contenus requis pour l'assemblage complet.	Asegúrese de que tiene todos los contenidos necesarios para el ensamblaje completo.
Take care when lifting. Assemble the product in close proximity to where you intend to install it.	Prenez soin de soulever. Assemblez le produit à proximité de l'endroit où vous comptez positionner l'élément.	Tenga cuidado al levantar. Ensamble el producto cerca de donde tiene la intención de posicionar el artículo.
Do not over tighten the screws and bolts as this may damage the threads.	Ne serrez pas trop les vis et les boulons car cela pourrait endommager les filets.	No apriete excesivamente los tornillos y pernos, ya que esto puede dañar los hilos.
Do not let children play with this product.	Ne laissez pas les enfants jouer avec ce produit.	No permita que los niños jueguen con este producto.
 Risk of suffocation! Keep packaging materials away from children.	 Risque asphyxiel! Tenez tous les matériaux emballage à l'écart des enfants	 Riesgo de sofocación! Mantenga los materiales de emb/alaje lejos de los niños.
Lamp Care Instructions	Entretien de la Lampe	Instrucciones de Lámparas
Carefully read through the instruction sheet before assembly and using the product.	Avant de procéder à l'assemblage et à l'utilisation de la lampe, lisez attentivement le mode d'emploi.	Lea cuidadosamente la hoja de instrucciones (si fue proporcionada) antes de armar y utilizar la lámpara.
 Caution there is a risk of shock! Disconnect from power source before assembling or cleaning.	 Pour éviter tout risque d'électrocution, débranchez la lampe de la prise électrique avant de procéder à l'assemblage ou au nettoyage de la lampe.	 Peligro por descarga eléctrica. Desconecte la lámpara de la fuente de electricidad antes de armarla o limpiarla.
Switch off, unplug and allow bulb to cool before replacing bulb or cleaning.	Avant de remplacer ou de nettoyer l'ampoule, éteignez et débranchez la lampe.	Apáguela, desenchúfela y deje que la bombilla se enfríe antes de reemplazarla o limpiarla.
Only use the recommended bulb type and do not exceed the maximum wattage as it could cause fire.	Afin d'éviter tout risque de feu, utilisez le type et la puissance d'ampoule recommandés.	Solo utilice el tipo de bombilla recomendado y no exceda la potencia eléctrica máxima ya que puede causar un incendio.
Check the product cord to be sure is free torn or frayed.	Ne branchez pas la lampe si son cordon d'alimentation est déchiré ou effiloché	No conecte la lámpara si el cable eléctrico está dañado o deshilachado.
 WARNING: Wires must be connected to low voltage driver and should not be connected directly to live wire or a short may occur.	 AVERTISSEMENT : Les fils doivent être connectés au conducteur et ne doivent pas être connectés directement aux fils sous tension	 ADVERTENCIA: Los cables deben estar conectados al controlador y no deben conectarse directamente al cable activo
Cleaning & Maintenance	Nettoyage et Maintenance	Limpeza y Mantenimiento
On polished finishes, often using talc powder can reduce the appearance of fingerprints and other smudges.	Sur les finitions polies, souvent en utilisant la poudre de talc réduit l'apparence des empreintes digitales et d'autres taches.	En acabados pulidos, a menudo usando polvo de talco reduce la aparición de huellas dactilares y otras manchas.
For respective shade surfaces, use the appropriate cleansers, i.e. glass cleaner, stone polish, & wood polish.	Pour les surfaces d'ombrage respectives, utilisez les nettoyants appropriés, c'est-à-dire le nettoyant pour vitres, vernis à pierre et le vernis à bois.	Para las respectivas superficies de sombra, utilice los limpiadores apropiados, es decir, limpiador de vidrio, esmalte acrílico y pulido de madera.
Clean with soft cloth and a mild detergent. Do not use abrasive or harsh cleaners.	Nettoyer avec un chiffon doux et un détergent doux. N'utilisez pas de nettoyant abrasif.	Utilice un trapo limpio, suave y seco que no raye ni manche la superficie cuando quite el polvo.
Periodically (every 90-180 days) make sure that the screws are fully tightened.	Périodiquement (tous les 90-180 jours), assurez-vous que les vis sont bien serrées.	Periódicamente (cada 90-180 días) asegúrese de que los tornillos estén bien apretados.
Prolonged exposure to heat sources may cause glazing, melting and scorching, or even cause color to fade.	Si le tissu subit une exposition prolongée aux sources de chaleur, il pourrait commencer à reluire, à roussir, à s'estomper ou même à se décolorer.	La exposición prolongada a las fuentes de calor causa cristalización, derretimiento, quemadura y decoloración del tapizado.

Eng PARTS







Fra PIÈCES

Esp PARTES

Before getting started, ensure the package contains the following components:

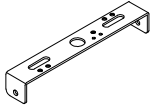
Antes de comenzar, asegurese de que el paquete contenga los siguientes componentes:

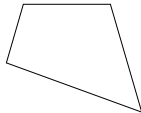
Avant de commencer, assurez-vous que le paquet contient les composants suivants:

<p>(A)</p>		<p>x1</p>	<p>(H)</p>		<p>x1</p>
			<p>(I)</p>	<p>HLU35007TDG</p> <p>LED CVorCC DRIVER 120V 17-20V or 350mA</p> <p>L3.2" *W1.7" *H1" or see diagram</p>	<p>x1</p>
<p>(B)</p>	 <p>M4*L12 SCREW</p>	<p>x2</p>			
<p>(C)</p>		<p>x1</p>			
<p>(D)</p>	 <p>#8-32*L25 SCREW</p>	<p>x2</p>			
<p>(E)</p>		<p>x3</p>			
<p>(F)</p>	 <p>ESHD21441-MG</p>	<p>x1</p>			
<p>(G)</p>	 <p>EDIF043</p>	<p>x1</p>			

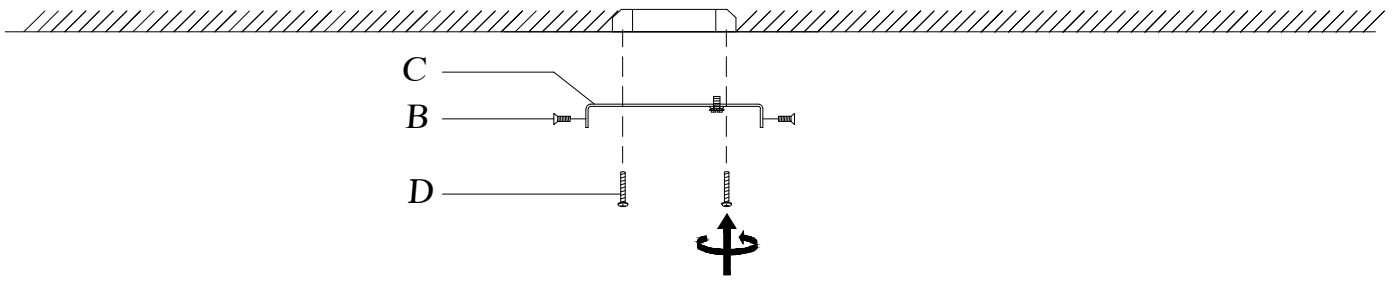

1.

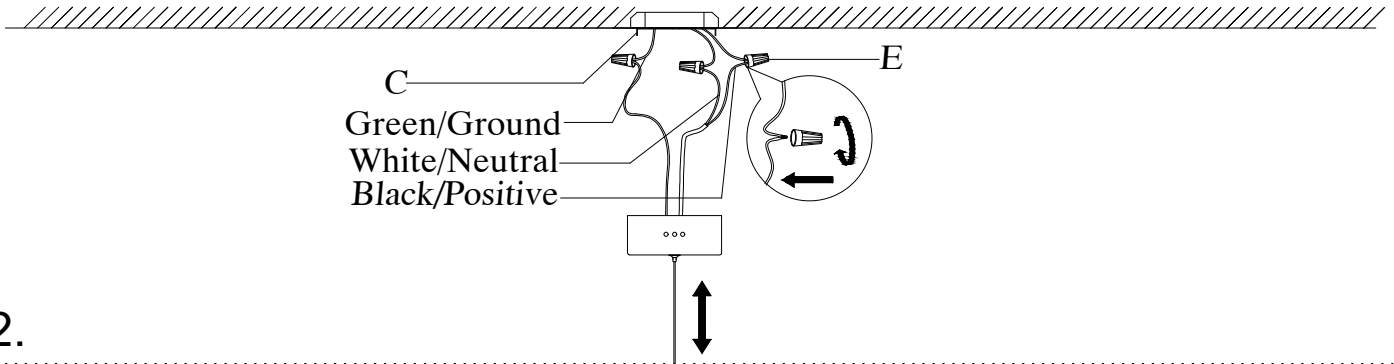

2.

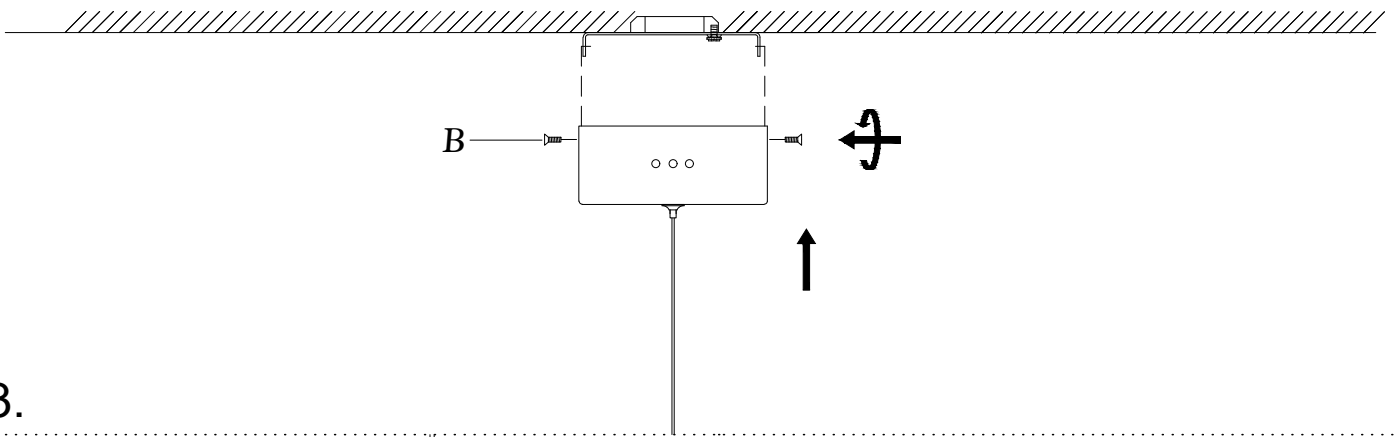

3.

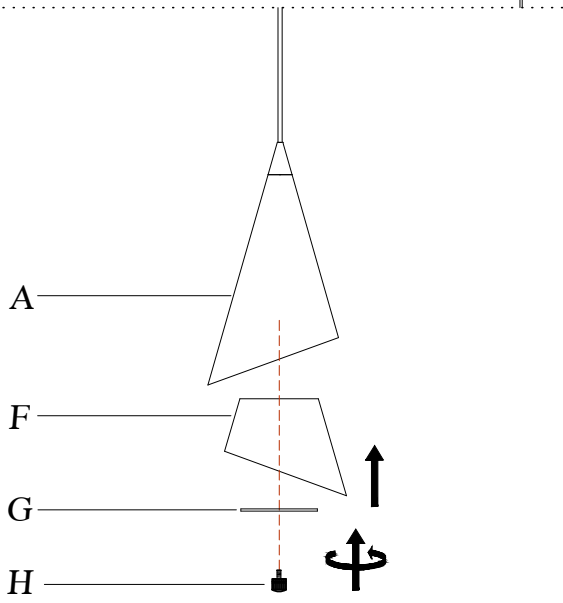

4.

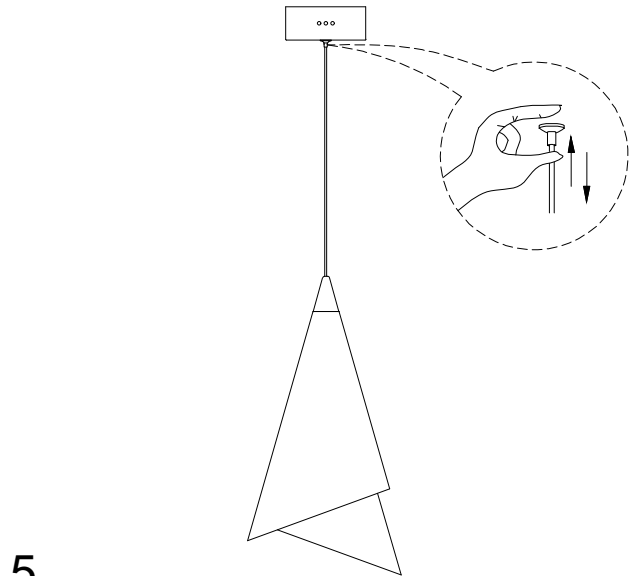

5.



ITEM/MODEL:21441

MUST be installed by an experienced professional
CRITICAL KNOWLEDGE of electronic lighting systems required

IMPROPER WIRING and/or INCORRECT DIMMER use can cause **CATASTROPHIC DAMAGE!**

THIS FIXTURE MUST BE INSTALLED with a COMPATIBLE DIMMER SWITCH

DO NOT CUT FACTORY-MADE CONNECTIONS.

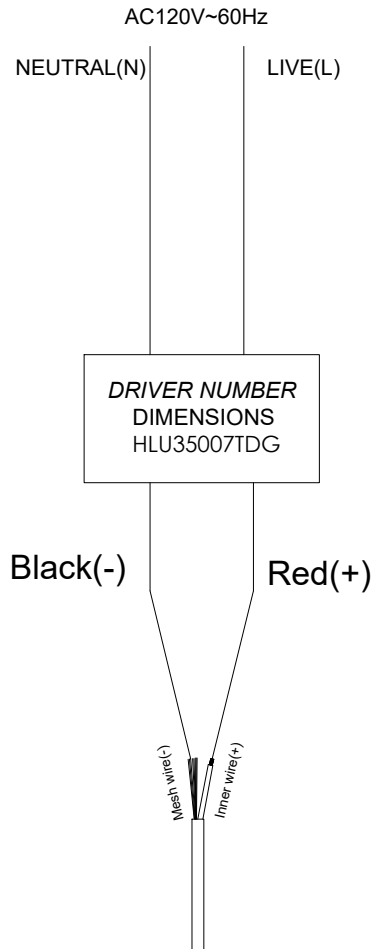

FACTORY CONNECTIONS
(+) INNER CONDUCTOR | OUTER MESH (-)

LED DRIVER DIAGRAM

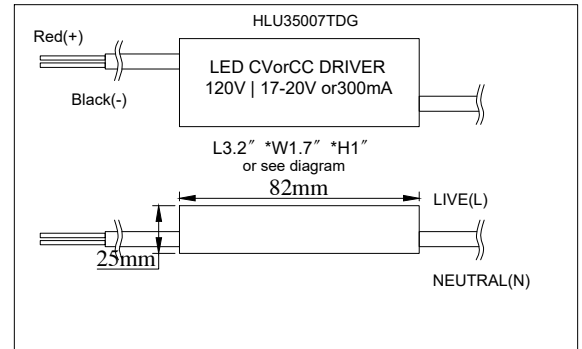

SCHMATIC
FOR GENERAL
REFERENCE ONLY

VERIFIED LIST OF TESTED DRIVERS

- Lutron DVCL-153P
- Lutron SCL-153P
- Leviton IPLO6
- Leviton 6674
- Deako Simple Dimmer

Due to inrush current, wattage should not exceed 150W on a 600W dimmer

GENERAL COMPATIBILITY

**TRIAC / FORWARD PHASE ELV/
REVERSE PHASE**
0-10V / LOW VOLTAGE
WiFi / WIZ Connected

IMPORTANT!

If the control is not paired properly to LED fixtures, irreparable damage may occur.

If the dimmer you are using is not listed here, consult a lighting professional or view our Dimming Compatibility Chart online:

www.et2online.com